

## KLT-J4K-OV2732 V3.0

### 2MP OmniVision OV2732 MIPI- und DVP-Parallelschnittstelle Fester Fokus Kameramodul

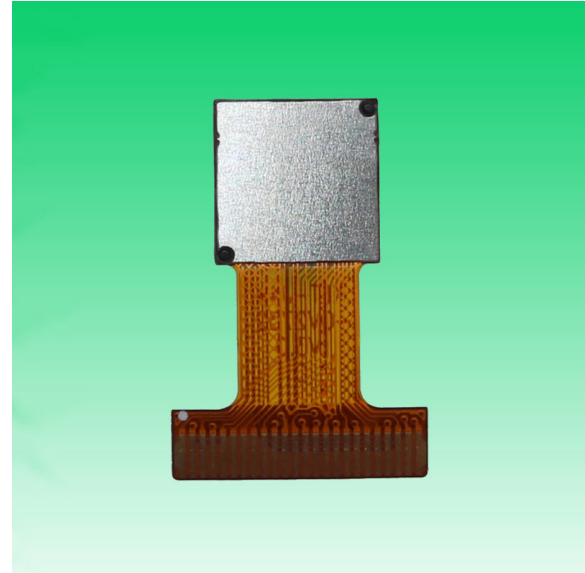

Vorderansicht



Rückansicht

#### Spezifikationen

<b>Kameramodul Nr.</b>	<b>KLT-J4K-OV2732 V3.0</b>
<b>Auflösung</b>	2MP
<b>Bildsensor</b>	OV2732
<b>Sensorart</b>	1/4"
<b>Pixel Größe</b>	2.0 um x 2.0 um
<b>EFL</b>	3.29 mm
<b>F.NO</b>	2.80
<b>Pixel</b>	1920 x 1080
<b>Betrachtungswinkel</b>	68.7°(DFOV) 58.1°(HFOV) 45.0°(VFOV)
<b>Linsenabmessungen</b>	8.00 x 8.00 x 4.90 mm
<b>Modulgröße</b>	18.50 x 12.50 mm
<b>Modultyp</b>	Fester Fokus
<b>Schnittstelle</b>	MIPI und DVP-Parallel
<b>Autofokus-VCM-Treiber-IC</b>	Keiner
<b>Linsenmodell</b>	KLT-LENS-M5101
<b>Linsentyp</b>	650 nm IR-Schnitt
<b>Betriebstemperatur</b>	-40°C to +85°C
<b>Gegenstecker</b>	FH12-24S-0.5SH

**KLT-J4K-OV2732 V3.0**  
**2MP OmniVision OV2732 MIPI- und DVP-Parallelschnittstelle**  
**Fester Fokus Kameramodul**



Ansicht von oben



Seitenansicht



Untersicht

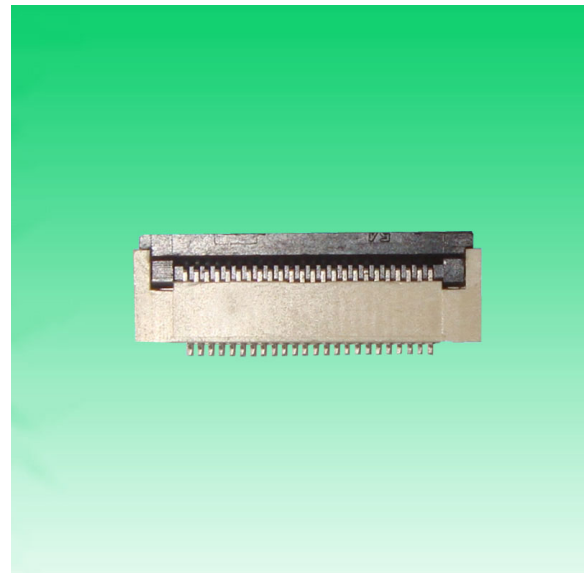

Gegenstecker

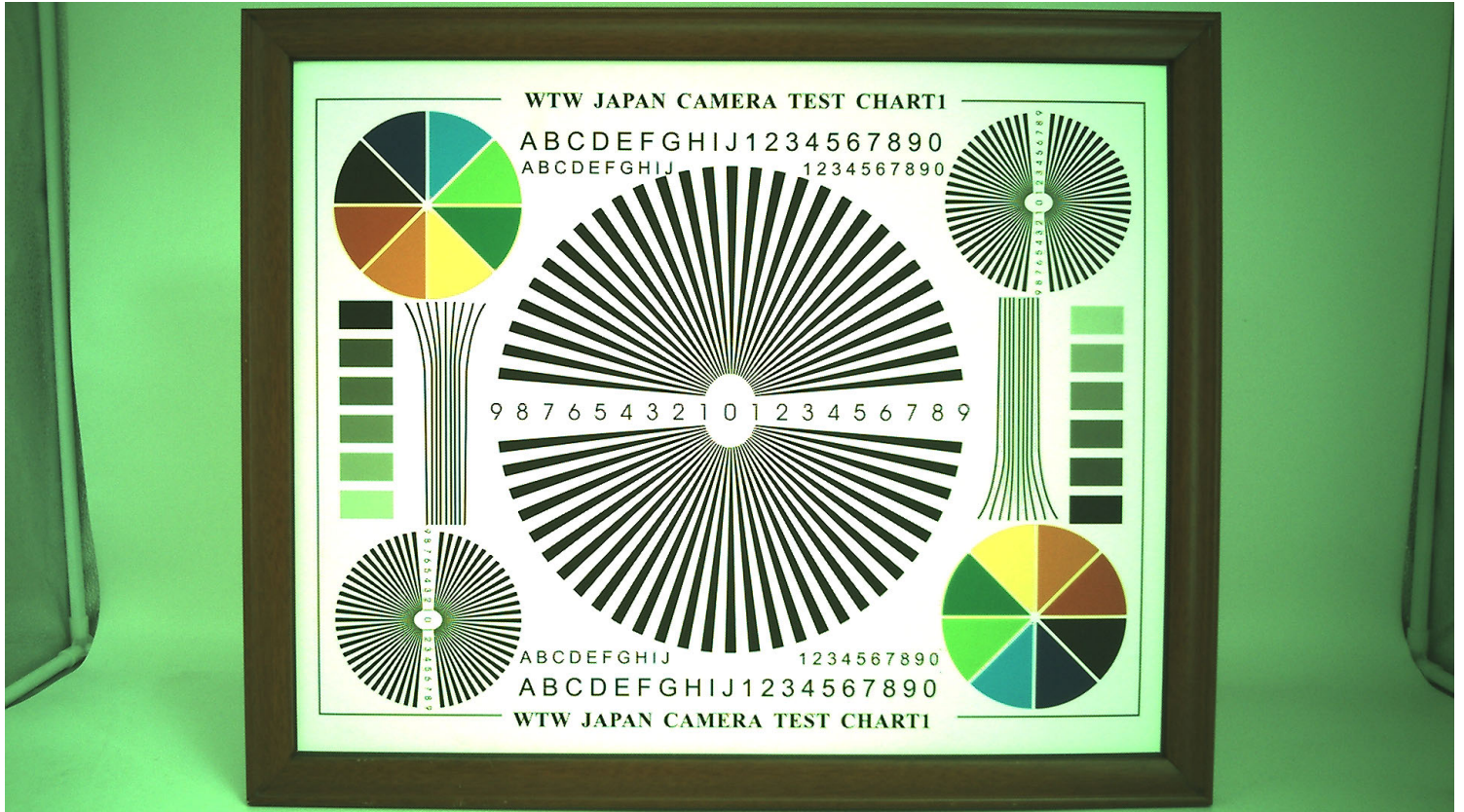

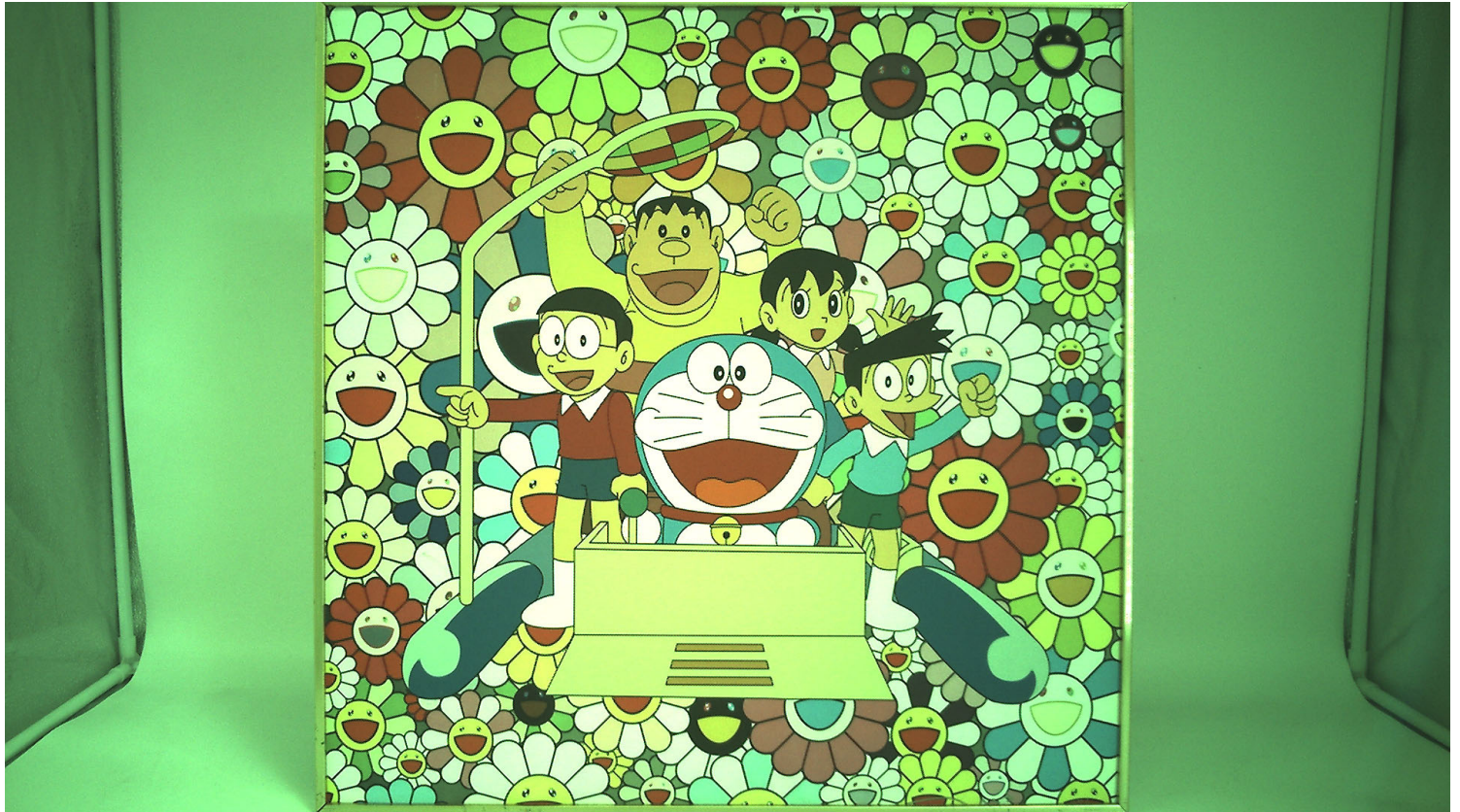

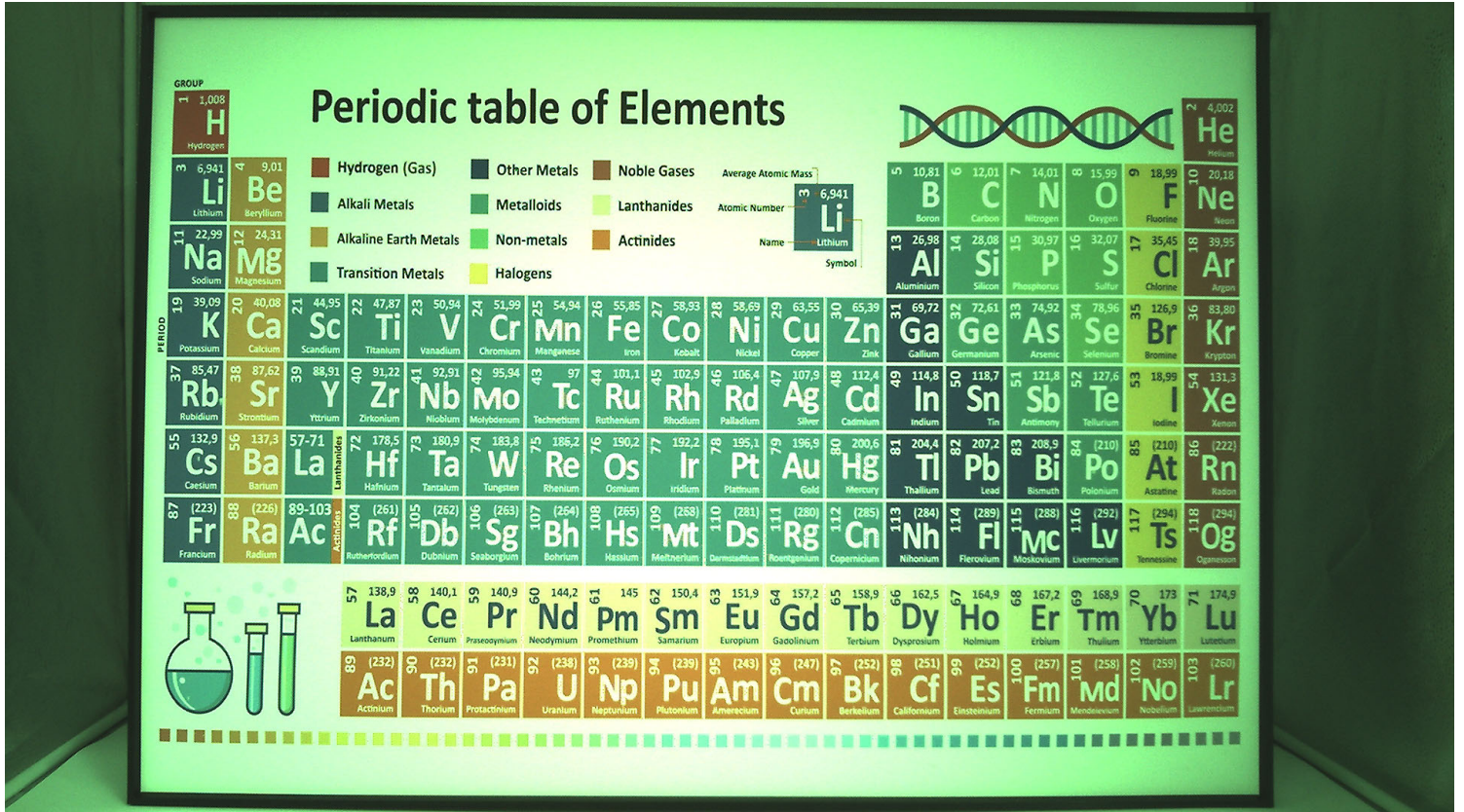

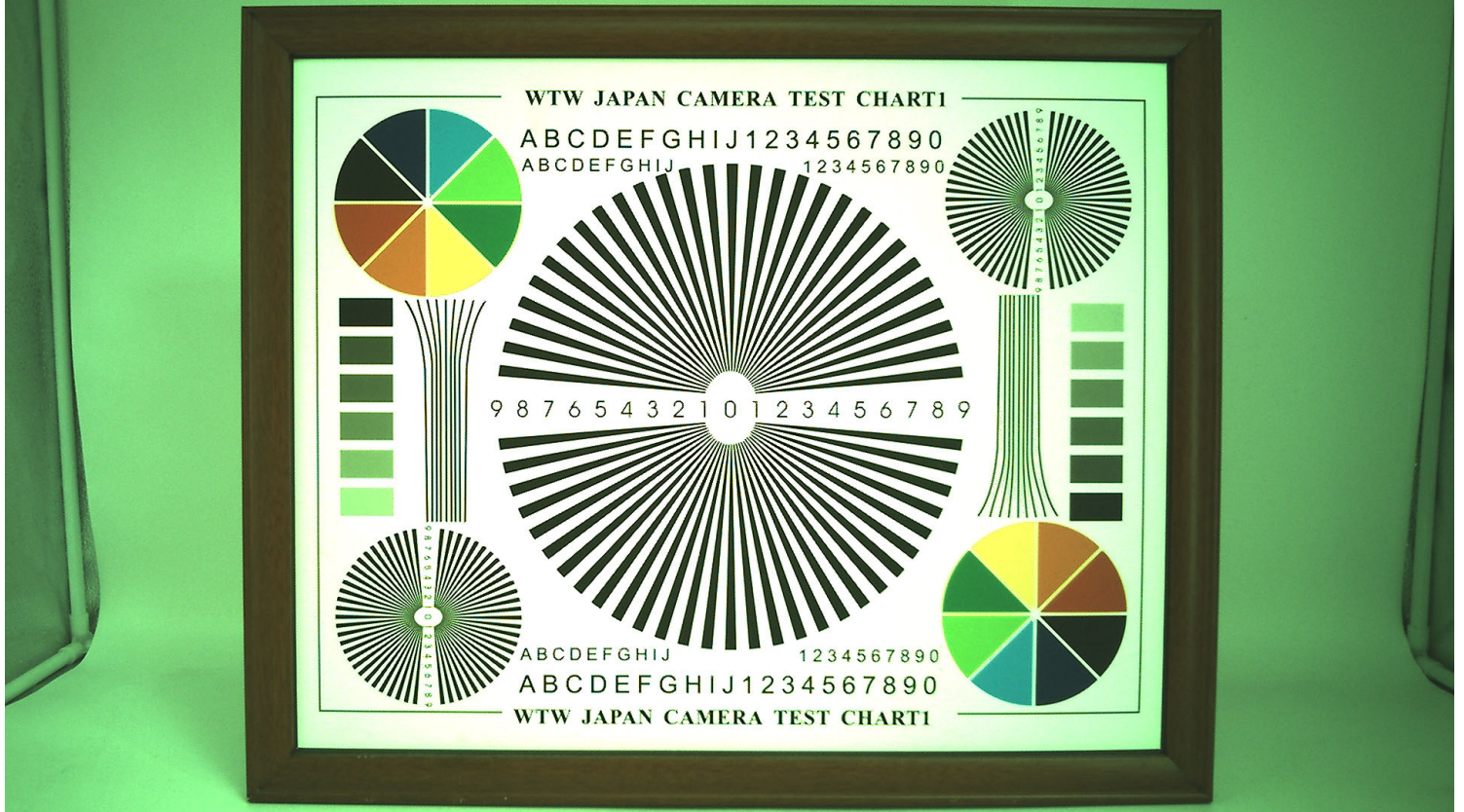

# ROHS

NO	SIGNAL
1	FSIN
2	AGND
3	SIO_D
4	AVDD2.8
5	SIO_C
6	RESET
7	VSYNC
8	PWDN
9	HREF
10	DVDD1.2
11	DOVDD1.8
12	D9/MDN1
13	MCLK
14	D8/MDP1
15	DGND
16	D7/MCN
17	PCLK
18	D6/MCP
19	D2
20	D5/MDN0
21	D3
22	D4/MDP0
23	D10
24	D11

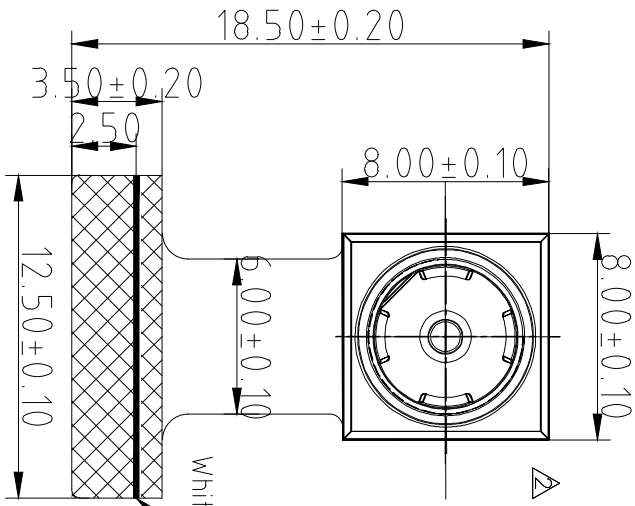
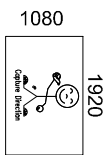

TOP VIEW

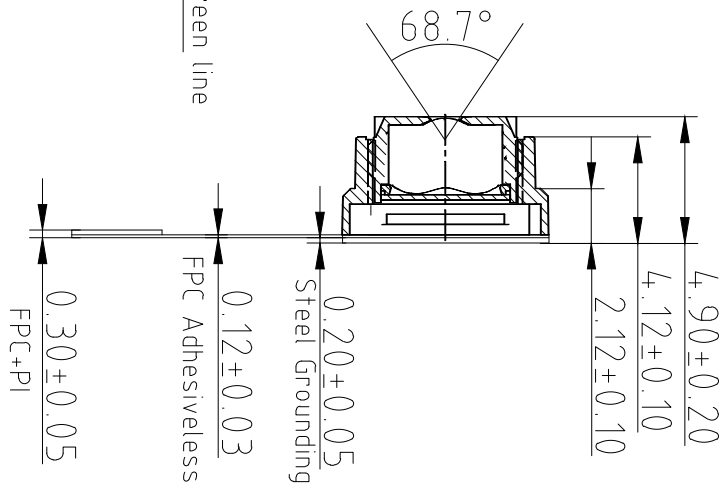

SIDE VIEW

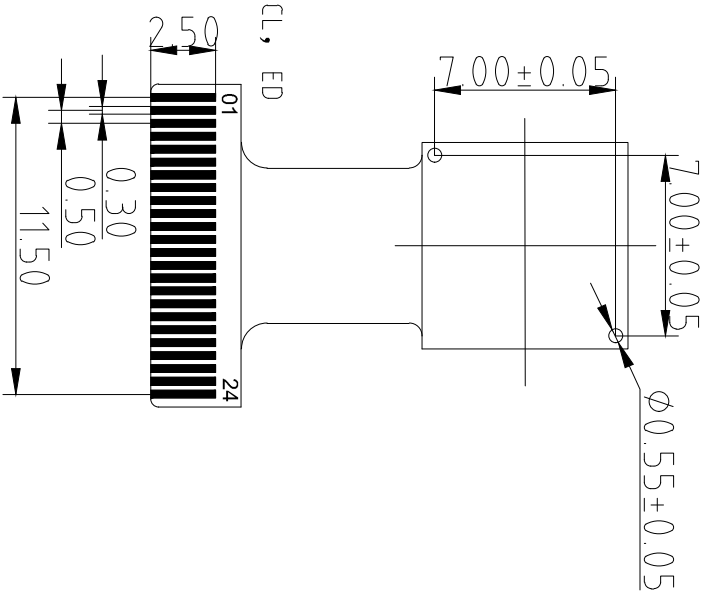

BOTTOM VIEW

NOTE:  
1.The device slave address:0x20(w);0x21(r)

Kai Lap Technologies Group Ltd

## Parameters:

### 1、Sensor specification:

Image Sensor: OV2732  
Pixel: 2umx2um  
Lens Type: 1/4  
Important Voltage Description: DVDD1.2V  
(external power supply);

### 2、Lens specification:

FOV: 68.7°  
F/NO.: 2.8  
TV distortion: <1.0%  
Focal length: 3.29mm  
Composition: 4P+IR FILTER  
IR Cut Coating: 650nm±10nm@50%

Version Mark	Information	Date
V1.0	PD First Version	07-15-2017
V3.0	Change lens and holder;Add PIN FSIN	02-15-2020

Designed By	Kevin	Model Name:	KLT-J4K-OV2732 V3.0		
Checked By	Aouly Yan	Projection Type:	Unit:	Material:	
		Third Angle	mm		
			Scale:	Sheet:	Version:
			1:1	1 of 1	1/0

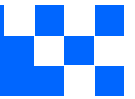

Lens Model: KLT-LENS-M5101

SPECIFICATION		
1. SENSOR SIZE	1/4" (5M CSP)	
2. MAX IMAGE CIRCLE	24.90mm	
3. TOTAL TRACK	4.18±0.1mm	
4. BFL	3.29mm	
5. OPTICAL BFL	1.43mm	
6. MECHANICAL BFL	0.85mm	
7. F/NO	2.8±5%	
8. VIEW OR FIELD	VERTICAL	45.0° (V=1.38)
	HORIZONTAL	58.1° (V=1.814)
	DIAGONAL	68.7° (V=2.268)
9. OPTICAL DISTORTION	<1.0%	
10. TV DISTORTION	<1.0%	
11. RELATIVE ILLUMINATION	>42.3%	
12. CONSTRUCTION	4P+IR FILTER	
13. CHIP RAY ANGLE	<25°	
14. CUT FREQUENCY AT 50%	650±10nm	
15. THREAD	M6.0X0.35P	
16. IMAGE QUALITY	AXIS	330Lp/mm
	0.7Y	200Lp/mm
17. APPEARANCE QUALITY (Scratch/Dig)	CENTER	20/10
	EDGE	40/20

**NOTE:**

1. 镜头表面不可有油污、灰尘、毛丝等异物。
2. 镜头配VCM锁附高度为 4.7±0.1mm, 扭力为20--60gf.cm。
3. 镜头承受推力为≥2.0kg。
4. 镜头品质参数需符合图中要求。

NO	MODIFY CONTENT	NAME	DATE
4			
3			
2			
1			

ANGLE	RANGE	DIM	TYPE	UNIT	MATERIAL	SCALE	APPROVED BY	FINISH	DATE	REVISION
ANGLE	±0.5°			m		8 : 1				
ANGLE	±0.010									
ANGLE	±0.05									
ANGLE	±0.1									

SURFACE	FINISH
NUMBER	NAME
A4	Johnson
DRAWING BY	DATE
2013.05.03	
CHECKED BY	
APPROVED BY	

REV.	DATE	DESCRIPTION
A-00		

# 0.5mm and 1mm Pitch Connectors For FPC/FFC

## FH12 Series

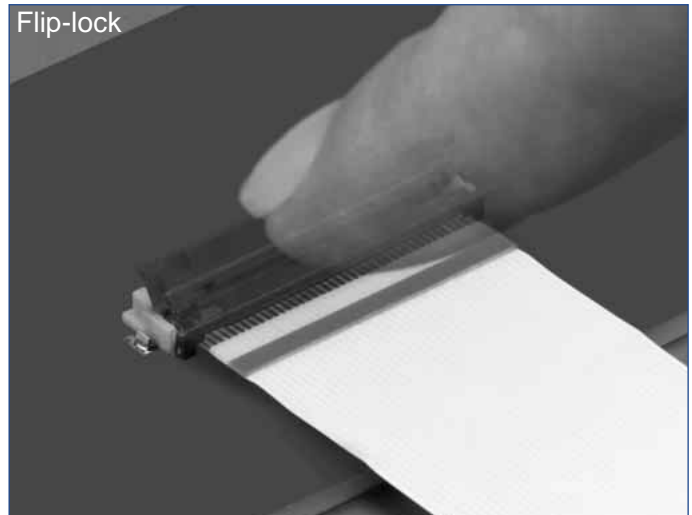
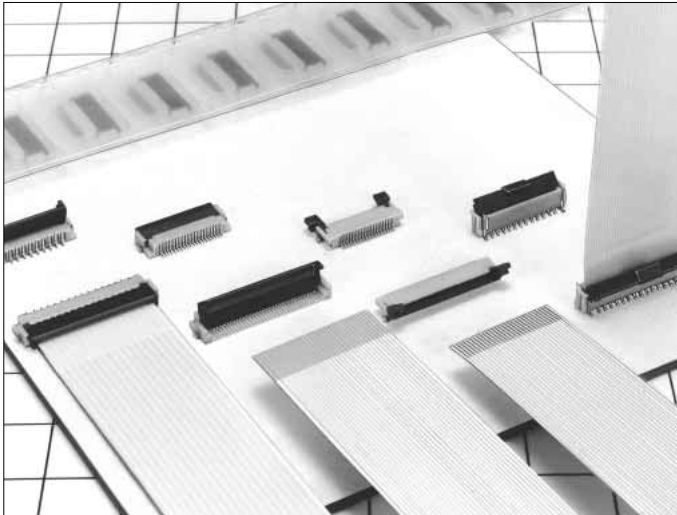

### ■ Features

#### 1. Ease of Use and Space Savings

Only one finger or 6.9N (Newtons) of force is required to lock Hirose's rotational actuator (flip-lock) as compared to using 2 fingers and 39.2N to close a FFC/FPC connector from our competition.

The Flip-Lock design also allows customers to place 2 or more connectors side by side as there is no need to waste additional board space for a side latch.

#### 2. Strengthened Flip-lock Actuator

The standard Flip-Lock requires only 2.0mm height above the board. A strengthened lock lever is available which only requires an additional 0.4mm.

#### 3. Supports Thin FPC (0.18mm)

Hirose does not require double-sided FPC to have any additional strengthening plate or stiffener and can therefore support a thickness of as little as 0.18mm +/- 0.05.

#### 4. Hirose Ensures Reliability

Hirose's patented half tuning fork contacts maintain the required normal force without relying on the connector housing. With our competitor's conventional products the housing walls support the contact force, which does not provide for long-term reliability.

#### 5. Prevention of Solder Bridge

Excess solder cavity absorbs excessive solder and avoids solder bridging.

#### 6. Three different assembly types

FH12 is offered in Top & Bottom Contact and Vertical Mount and offered in both a 0.5mm contact pitch as well as a 1.0mm contact pitch (bottom contact only).

### ■ Applications

Notebook computers, printers, PDAs, digital cameras and other compact devices for interconnecting the main circuit board with the LCD, HDD or other device.

#### Rotating One-touch Mechanism

①

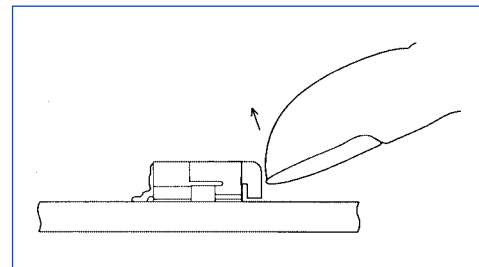

②

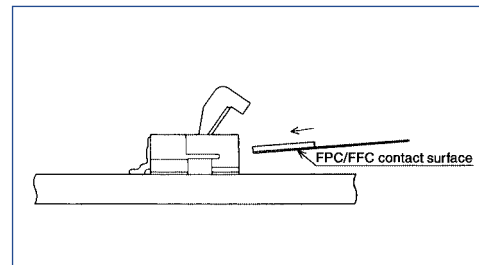

③

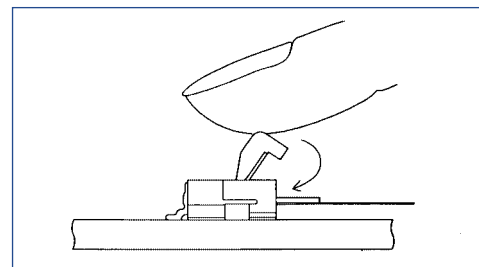

## Product Specifications

Rating	Current rating: 0.5A DC(Note 1)	Operating Temperature Range: -40 to +70°C (Note 2)	Storage Temperature Range: -10 to +50°C (Note 3)
	Voltage rating: 50V AC	Operating Humidity Range: Relative humidity, 90% max. (Not dewed)	Storage Humidity Range: Relative humidity, 90% max. (Not dewed)

Applicable FPC	t=0.3±0.05 Gold plated	t=0.18 ± 0.05 for FH12F-*S-0.5SH
----------------	------------------------	----------------------------------

Item	Specification	Conditions
1. Insulation resistance	500M ohms minimum	100V DC
2. Withstanding voltage	No flashover or insulation breakdown.	150V AC/1 minute
3. Contact resistance	50m ohms maximum	1mA
4. Durability (Insertion/withdrawal)	Contact resistance: 50m ohms maximum No damage, cracks, or parts dislocation.	20 cycles
5. Vibration	No electrical discontinuity of 1μs or more Contact resistance: 50m ohms maximum. No damage, cracks, or parts dislocation.	Frequency: 10 to 55 Hz, single amplitude of 0.75 mm, 2 hours in each of the 3 directions.
6. Shock	No electrical discontinuity of 1μs or more Contact resistance: 50m ohms maximum. No damage, cracks, or parts dislocation.	Acceleration of 490 m/s <sup>2</sup> , 11 ms duration, sine half-wave waveform, 3 cycles in each of the 3 axis.
7. Humidity(Steady state)	Contact resistance: 50m ohms maximum. Insulation resistance: 50M ohms minimum. No damage, cracks, or parts dislocation.	96 hours at 40°C and humidity of 90% to 95%
8. Temperature Cycle	Contact resistance: 50m ohms maximum. Insulation resistance: 50M ohms minimum. No damage, cracks, or parts dislocation.	Temperature: -40°C → 15 to 35°C → 85°C → 15 to 35°C, Time: 30 → 5 max. → 30 → 5 max.(minutes) 5 cycles
9. Resistance to Soldering heat	No deformation of components affecting performance.	Reflow: At the recommended temperature profile Manual soldering: 350±5°C for 3 seconds

Note 1: When passing the current through all of the contacts, use 70% of the current rating.

Note 2: Includes temperature rise caused by current flow.

Note 3: The term "storage" refers to products stored for long period of time prior to mounting and use. Operating Temperature Range and Humidity range covers nonconducting condition of installed connectors in storage, shipment or during transportation.

## Material

Part	Material	Finish	Remarks
Insulator	Polyamide, LCP(60 pos.)	Color : Beige	UL94V-0
Actuator	PPS	Color : Dark brown	
Contact	Phosphor bronze	Gold plated	
Metal Fittings	Brass	Tin plated	

## Ordering Information

**FH12**    **A** - **10** (**4**) - **S** **A** - **0.5** **SH** (**55**)  
 ①            ②            ③            ④            ⑤            ⑥            ⑦            ⑧            ⑨

① Series Name : FH12	⑤ Contact alignment: Single
② Blank : standard type A : Top contact type S : Type with strengthened flip-lock actuator F : Type with 0.18mm FPC End Thickness	⑥ Eccentric direction: Blank : standard type A : Eccentric type
③ Standard type : Number of contacts Eccentric type : Number of contacts in 0.5mm housing	⑦ Contacts Pitch : 0.5mm, 1mm
④ Standard type : Blank Eccentric type : Number of contacts	⑧ Contact type SH : SMT horizontal mounting type SV : SMT vertical mounting type
	⑨ Plating specification (55) : Gold plated

**FH12 Series 0.5mm and 1mm Pitch Connectors For FPC/FPC**

**Series Configuration**

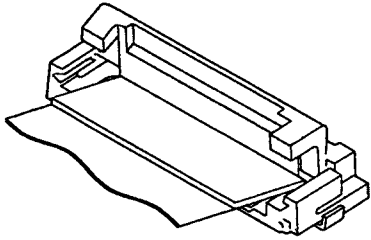
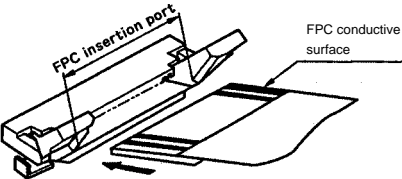
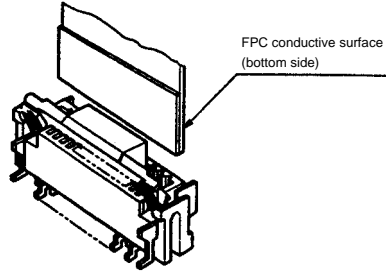
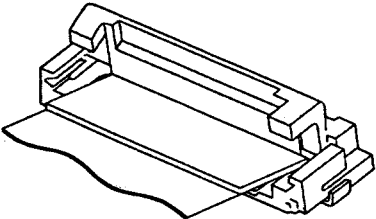
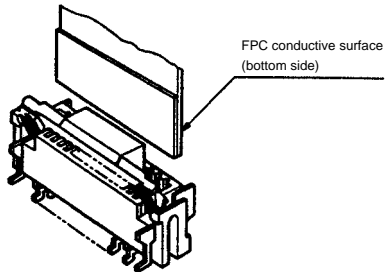
Pitch	Bottom Contact Type	Top Contact Type	Vertical mounting Type
0.5mm	 <p><b>FH12- ** S-0.5SH</b> <b>P.12</b>                      Number of contacts 6, 8, 10, 11, 12, 13, 14, 15, 16, 17, 18, 19, 20, 22, 24, 25, 26, 28, 30, 32, 33, 34, 35, 36, 40, 45, 50, 53</p>		
	Type with Strengthened Lock Lever		
	<p><b>FH12S- ** S-0.5SH</b> <b>P.13</b>                      Number of contacts 30, 40, 45, 50, 53</p>		
	Type with 0.18mm FPC End Thickness		
	<p><b>FH12F- ** S-0.5SH</b> <b>P.14</b>                      Number of contacts 6, 8, 10, 12, 13, 14, 15, 16, 18, 20, 22, 24, 25, 26, 28, 30, 32, 34, 36, 40</p>		
1mm	 <p>Standard <b>FH12- ** S-1SH</b> <b>P.18</b>                      Eccentric <b>FH12- ** (***) SA-1SH</b>                      Standard                      Number of contacts 5, 6, 7, 8, 9, 11, 12, 16, 17, 22, 26                      Eccentric                      Number of contacts 4, 6, 8, 10, 11, 14, 19, 24</p>		 <p><b>FH12- ** S-1SV</b> <b>P.19</b>                      Number of contacts 6, 7, 8, 16, 20, 22, 24</p>

## 0.5mm Pitch Bottom Contact Type

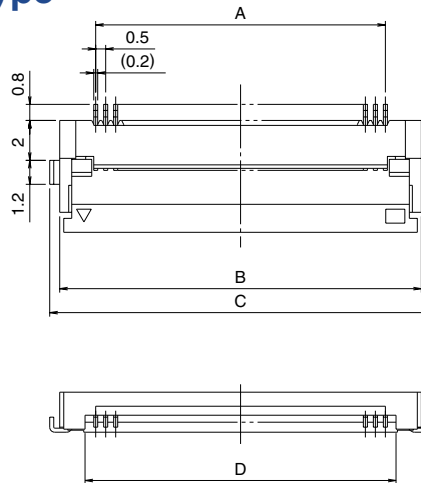

Mated Cross-sectional Diagram

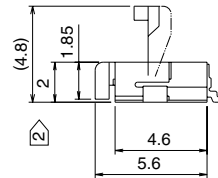
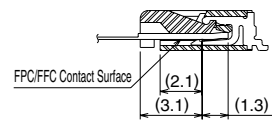

Unit:mm

Part Number	CL No.	Number of Contacts	A	B	C	D	RoHS
FH12- 6S-0.5SH(55)	586-0582-5-55	6	2.5	6.1	7.1	3.57	YES
FH12- 8S-0.5SH(55)	586-0744-5-55	8	3.5	7.1	8.1	4.57	
FH12-10S-0.5SH(55)	586-0522-3-55	10	4.5	8.1	9.1	5.57	
FH12-11S-0.5SH(55)	586-0600-5-55	11	5	8.6	9.6	6.07	
FH12-12S-0.5SH(55)	586-0704-0-55	12	5.5	9.1	10.1	6.57	
FH12-13S-0.5SH(55)	586-0549-0-55	13	6	9.6	10.6	7.07	
FH12-14S-0.5SH(55)	586-0533-0-55	14	6.5	10.1	11.1	7.57	
FH12-15S-0.5SH(55)	586-0523-6-55	15	7	10.6	11.6	8.07	
FH12-16S-0.5SH(55)	586-0531-4-55	16	7.5	11.1	12.1	8.57	
FH12-17S-0.5SH(55)	586-0606-1-55	17	8	11.6	12.6	9.07	
FH12-18S-0.5SH(55)	586-0530-1-55	18	8.5	12.1	13.1	9.57	
FH12-19S-0.5SH(55)	586-0534-2-55	19	9	12.6	13.6	10.07	
FH12-20S-0.5SH(55)	586-0524-9-55	20	9.5	13.1	14.1	10.57	
FH12-22S-0.5SH(55)	586-0532-7-55	22	10.5	14.1	15.1	11.57	
FH12-24S-0.5SH(55)	586-0521-0-55	24	11.5	15.1	16.1	12.57	
FH12-25S-0.5SH(55)	586-0692-3-55	25	12	15.6	16.6	13.07	
FH12-26S-0.5SH(55)	586-0576-2-55	26	12.5	16.1	17.1	13.57	
FH12-28S-0.5SH(55)	586-0612-4-55	28	13.5	17.1	18.1	14.57	
Note ② FH12-30S-0.5SH(55)	586-0525-1-55	30	14.5	18.1	19.1	15.57	
FH12-32S-0.5SH(55)	586-0681-7-55	32	15.5	19.1	20.1	16.57	
FH12-33S-0.5SH(55)	586-0520-8-55	33	16	19.6	20.6	17.07	
FH12-34S-0.5SH(55)	586-0617-8-55	34	16.5	20.1	21.1	17.57	
FH12-35S-0.5SH(55)	586-0740-4-55	35	17.0	20.6	21.6	18.07	
FH12-36S-0.5SH(55)	586-0526-4-55	36	17.5	21.1	22.1	18.57	
Note ② FH12-40S-0.5SH(55)	586-0527-7-55	40	19.5	23.1	24.1	20.57	
Note ② FH12-45S-0.5SH(55)	586-0528-0-55	45	22	25.6	26.6	23.07	
Note ② FH12-50S-0.5SH(55)	586-0529-2-55	50	24.5	28.1	29.1	25.57	
Note ② FH12-53S-0.5SH(55)	586-0595-7-55	53	26	29.6	30.6	27.07	

Note 1 : Embossed tape reel packaging (2,000 pieces/reel).  
 Order by number of reels.

Note ② : If there is no problem with the connector height, we recommend the type with the strengthened Flip-lock actuator (FH12S-\*S-0.5SH).  
 Standard type connector height: 2 mm  
 Connector height of type with strengthened Flip-lock actuator: 2.4 mm

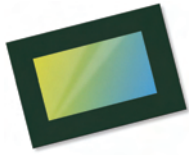

# OV2732 1080p product brief



## Low-Power 1080p High Definition PureCel® Sensor for Security Applications



available in  
a lead-free  
package

OmniVision's OV2732 is a compact and power-efficient PureCel® image sensor designed for IoT-based residential and commercial monitoring systems. The OV2732 captures quality images and videos with staggered high dynamic range (HDR), ensuring excellent scene reproduction in all lighting environments. The sensor features frame sync for use in multi-camera or 360-degree camera systems and supports ultra-low power mode (ULPM) and an ambient light sensor (ALS), making it particularly well-suited for battery-powered security applications.

Built on OmniVision's PureCel® technology, the 1/4-inch OV2732 captures 1080p high definition (HD) video at 60 frames per second (fps), 720p HD video at 90 fps, and VGA resolution video at 120 fps. The OV2732 delivers crisp images and video, even in challenging low-light conditions.

Find out more at [www.ovt.com](http://www.ovt.com).



## Applications

- Internet of Things (IoT)
- High-end Video Conferencing
- Security
- Lifestyle Camera
- Home Monitoring

## Product Features

- programmable controls:
  - gain
  - exposure
  - frame rate
  - image size
  - horizontal mirror
  - vertical flip
  - cropping
  - windowing
- automatic image control functions:
  - black level calibration (BLC)
- serial camera control bus (SCCB)
- defective pixel correction (DPC)
- digital video port (DVP) parallel output interface
- support for two lane MIPI interface (up to 800 Mbps)
- support for image sizes:
  - 1080p @ 60 fps
  - 720p @ 90 fps
  - VGA @ 120 fps
  - QVGA @ 240 fps, and more
- support for light sensing mode (LSM)
- support for staggered 2 frame HDR
- support for black sun cancellation
- on-chip phase lock loop (PLL)

# OV2732



## Ordering Information

- OV02732-H57A (color, lead-free, 57-pin CSP4)

## Product Specifications

- active array size: 1920 x 1080
- power supply:
  - core: 1.2V
  - analog: 2.8V
  - I/O: 1.8V
- power requirements:
  - active: 110 mW
- temperature range:
  - operating: -40°C to +85°C junction temperature
  - stable image: 0°C to +60°C junction temperature
- output interfaces:
  - two-lane MIPI / DVP parallel
- output formats: 10/12-bit RAW RGB
- lens size: 1/4"
- lens chief ray angle: 12° linear
- input clock frequency: 6 - 27 MHz
- scan mode: progressive
- maximum image transfer rate:
  - 1080p: 60 fps
  - 720p: 90 fps
  - VGA: 120 fps
  - QVGA: 240 fps
- shutter: rolling shutter
- maximum exposure interval: 1184 x t<sub>row</sub>
- pixel size: 2 μm x 2 μm
- image area: 3868 μm x 2190 μm
- package dimensions: 5174 μm x 3680 μm

## Functional Block Diagram

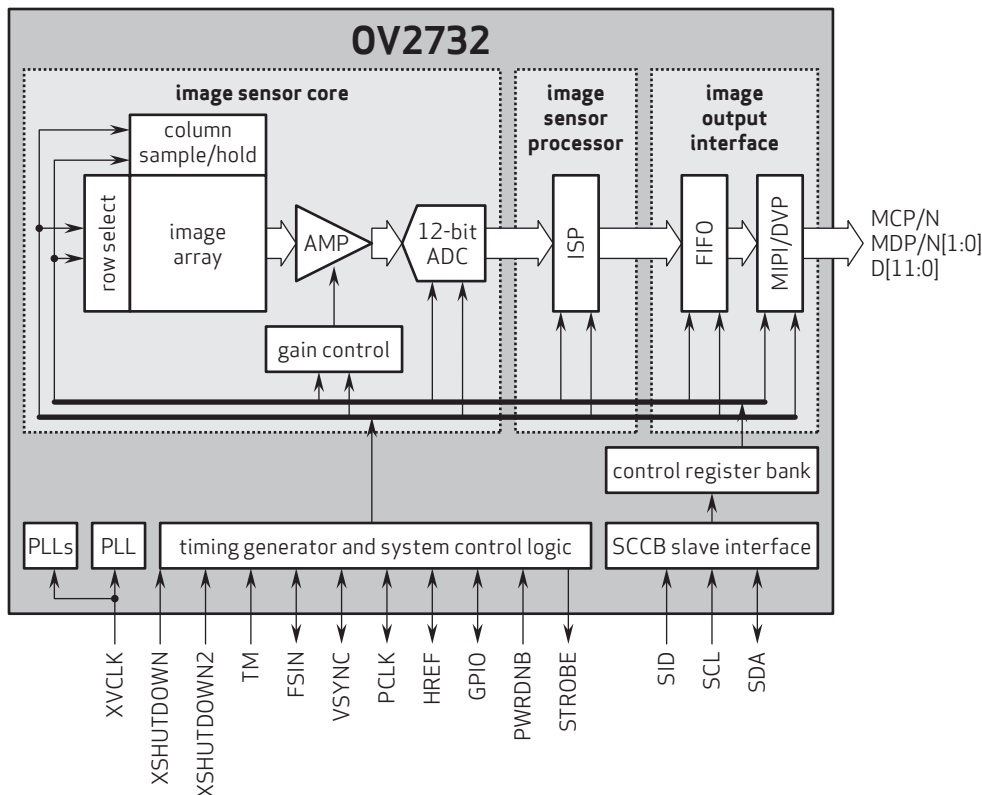

4275 Burton Drive  
Santa Clara, CA 95054  
USA

Tel: + 1 408 567 3000  
Fax: + 1 408 567 3001  
www.ovt.com

OmniVision reserves the right to make changes to their products or to discontinue any product or service without further notice. OmniVision, the OmniVision logo and OmniPixel are registered trademarks of OmniVision Technologies, Inc. OmniBSI-2 is a trademark of OmniVision Technologies, Inc. All other trademarks are the property of their respective owners.



OmniVision

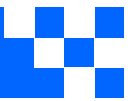

Kameraanwendungen

*your BEST camera module partner*



Autopilot



Live-Streaming



Videokonferenz



Biometrische Eye-Tracker-Erkennung

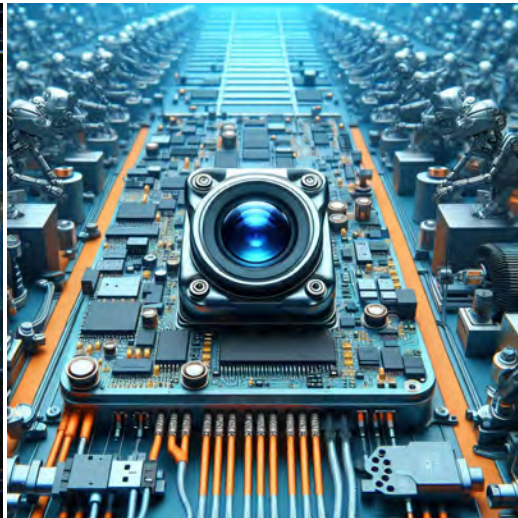

Maschinelles Sehen



Agrarmonitor



Nachtsichtsicherheit



Drohnen- und Sport-Adleraugen



Interaktive Haustierkamera

[www.KaiLapTech.com](http://www.KaiLapTech.com) [sales@KaiLapTech.com](mailto:sales@KaiLapTech.com) Tel: (852) 6908 1256 Fax: (852) 3017 6778



*your BEST camera module partner*

## Kameraanwendungen



### IMAGING DEVICES





Referenztable für die Pinbelegungsdefinition des Kameramoduls

OmniVision Sony Himax Samsung On-Semi Aptina Himax GalaxyCore PixArt Bildsensoren	
Pin Signal	Beschreibung
DGND GND	Masse für digitale Schaltung
AGND	Masse für analoge Schaltung
PCLK DCK	DVP-PCLK-Ausgang
XCLR PWDN XSHUTDOWN STANDBY	Abschalten aktiv hoch mit internem Pulldown-Widerstand
MCLK XVCLK XCLK INCK	Systemeingangsuhr
RESET RST	Aktiv Low mit internem Pull-up-Widerstand zurücksetzen
NC NULL	keine Verbindung
SDA SIO_D SIOD	SCCB-Daten
SCL SIO_C SOIC	SCCB-Eingangstakt
VSYNC XVS FSYNC	DVP-VSYNC-Ausgang
HREF XHS	DVP-HREF-Ausgang
DOVDD	Strom für E/A-Schaltung
AFVDD	Strom für VCM-Schaltung
AVDD	Strom für analoge Schaltung
DVDD	Strom für digitale Schaltung
STROBE FSTROBE	Strobe-Ausgang
FSIN	Synchronisieren Sie das VSYNC-Signal vom anderen Sensor
SID	SCCB letzte Bit-ID-Eingabe
ILPWM	mechanische Shutter-Ausgangsanzeige
FREX	Rahmenbelichtung / mechanischer Verschluss
GPIO	Allzweckeingänge
SLASEL	I2C-Slave-Adresse auswählen
AFEN	CEN-Chip aktivieren aktiv hoch auf VCM-Treiber-IC
<b>MIPI Schnittstelle</b>	
MDN0 DN0 MD0N DATA_N DMO1N	MIPI 1st negative Ausgabe der Datenspur
MDP0 DP0 MD0P DATA_P DMO1P	MIPI 1st positiver Ausgang der Datenspur
MDN1 DN1 MD1N DATA2_N DMO2N	MIPI 2nd negative Ausgabe der Datenspur
MDP1 DP1 MD1P DATA2_P DMO2P	MIPI 2nd positiver Ausgang der Datenspur
MDN2 DN2 MD2N DATA3_N DMO3N	MIPI 3rd negative Ausgabe der Datenspur
MDP2 DP2 MD2P DATA3_P DMO3P	MIPI 3rd positiver Ausgang der Datenspur
MDN3 DN3 MD3N DATA4_N DMO4N	MIPI 4th negative Ausgabe der Datenspur
MDP3 DP3 MD3P DATA4_P DMO4P	MIPI 4th positiver Ausgang der Datenspur
MCN CLKN CLK_N DCKN	MIPI Uhr negativer Ausgang
MCP CLKP MCP CLK_P DCKN	MIPI Takt positiver Ausgang
<b>DVP Parallel Schnittstelle</b>	
D0 DO0 Y0	DVP Datenausgabeport 0
D1 DO1 Y1	DVP Datenausgabeport 1
D2 DO2 Y2	DVP Datenausgabeport 2
D3 DO3 Y3	DVP Datenausgabeport 3
D4 DO4 Y4	DVP Datenausgabeport 4
D5 DO5 Y5	DVP Datenausgabeport 5
D6 DO6 Y6	DVP Datenausgabeport 6
D7 DO7 Y7	DVP Datenausgabeport 7
D8 DO8 Y8	DVP Datenausgabeport 8
D9 DO9 Y9	DVP Datenausgabeport 9
D10 DO10 Y10	DVP Datenausgabeport 10
D11 DO11 Y11	DVP Datenausgabeport 11

## Kamera-Zuverlässigkeitstest

Reliability Inspection Item		Testmethode	Akzeptanzkriterium	
Kategorie	Artikel			
Umwelt	Lager Temperatur	Hoch 60°C 96 Std	Temperaturkammer	Keine anormale Situation
		Niedrig -20°C 96 Std	Temperaturkammer	Keine anormale Situation
	Betriebs Temperatur	Hoch 60°C 24 Std	Temperaturkammer	Keine anormale Situation
		Niedrig -20°C 24 Std	Temperaturkammer	Keine anormale Situation
	Feuchtigkeit	60°C 80% 24 Std	Temperaturkammer	Keine anormale Situation
	Thermischer Schock	Hoch 60°C 0.5 Std Niedrig -20°C 0.5 Std Radfahren rein 24 Std	Temperaturkammer	Keine anormale Situation
Physisch	Falltest (Im freien Fall)	Ohne Verpackung 60cm	10 Mal auf Holzboden	Elektrisch funktionsfähig
		Mit Paket 60cm	10 Mal auf Holzboden	Elektrisch funktionsfähig
	Vibrations Test	50Hz X-Axis 2mm 30 Minuten	Vibrationstisch	Elektrisch funktionsfähig
		50Hz Y-Axis 2mm 30 Minuten	Vibrationstisch	Elektrisch funktionsfähig
		50Hz Z-Axis 2mm 30 Minuten	Vibrationstisch	Elektrisch funktionsfähig
	Zugfestigkeit des Kabels Krafttest	Gewicht laden 4 kg 60 Sekunden Radfahren rein 24 Std	Zugprüfmaschine	Elektrisch funktionsfähig
Elektrisch	ESD-Test	Kontaktaufnahme 2 KV	ESD-Prüfmaschine	Elektrisch funktionsfähig
		Luftentladung 4 KV	ESD-Prüfmaschine	Elektrisch funktionsfähig
	Alterungstest	On/Off 30 Sekunden Radfahren rein 24 Std	Stromschalter	Elektrisch funktionsfähig
	USB-Anschluss	On/Off 250 Mal	Einstecken und ausstecken	Elektrisch funktionsfähig





Inspektionsgegenstand		Untersuchungsmethode	Inspektionsstandard	
Kategorie	Artikel			
Aussehen	FPC oder PCB	Farbe	Das bloße Auge	Größere Unterschiede sind nicht zulässig.
		Zerrissen/gehackt werden	Das bloße Auge	Das Freilegen von Kupferrissen ist nicht zulässig.
		Markierung	Das bloße Auge	Klar, erkennbar (innerhalb von 30 cm Entfernung)
	Halterin	Kratzer	Das bloße Auge	Die Freilegung von Rissen im Inneren ist nicht zulässig
		Lücke	Das bloße Auge	Erfüllen Sie den Höhenstandard
		Schraube	Das bloße Auge	Stellen Sie sicher, dass Schrauben vorhanden sind (falls vorhanden)
		Schaden	Das bloße Auge	Die Freilegung von Rissen im Inneren ist nicht zulässig
	Linse	Kratzen	Das bloße Auge	Keine Auswirkung auf den Auflösungsstandard
		Kontamination	Das bloße Auge	Keine Auswirkung auf den Auflösungsstandard
		Ölfilm	Das bloße Auge	Keine Auswirkung auf den Auflösungsstandard
		Abdeckband	Das bloße Auge	Kein Problem beim Aussehen.
	Funktion	Bild	Keine Kommunikation	Testboard
Helles Pixel			Tafel	Im Image Center nicht erlaubt
Dunkles Pixel			Weißer Tafel	Im Image Center nicht erlaubt
Verschwommen			Das bloße Auge	Nicht erlaubt
Kein Bild			Das bloße Auge	Nicht erlaubt
Vertikale Linie			Das bloße Auge	Nicht erlaubt
Horizontale Linie			Das bloße Auge	Nicht erlaubt
Kleines Leck			Das bloße Auge	Nicht erlaubt
Blinkendes Bild			Das bloße Auge	Nicht erlaubt
Prellung			Inspektionslehre	Nicht erlaubt
Auflösung			Diagramm	Folgt dem Diagrammstandard für ausgehende Inspektionen
Farbe			Das bloße Auge	Kein Problem
Lärm			Das bloße Auge	Nicht erlaubt
Ecke dunkel			Das bloße Auge	Weniger als 100 x 100 Pixel
Farbauflösung	Das bloße Auge	Kein Problem		
Abmessungen	Höhe	Das bloße Auge	Follows Approval Data Sheet	
	Breite	Das bloße Auge	Follows Approval Data Sheet	
	Länge	Das bloße Auge	Follows Approval Data Sheet	
	Gesamt	Das bloße Auge	Follows Approval Data Sheet	



## KLT-Paketlösungen

KLT Kameramodul

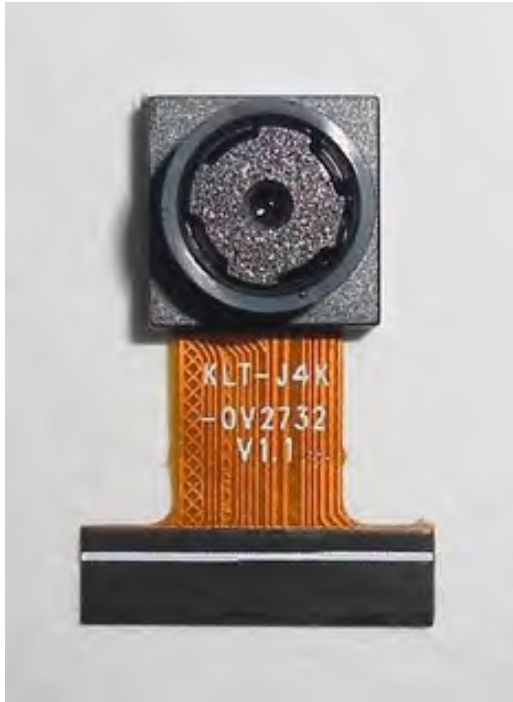

Komplett mit Linsenschutzfolie



Tablett mit Gitter und Raum



Legen Sie die Kameras auf das Tablett



## Paketlösung für Kameramodule

Volles Tablett mit Kameras



Abdeckschale mit Deckel



In Antistatikbeutel stecken



Staubsaugen Sie den antistatischen Beutel





## Paketlösung für Kameramodule

Versiegelter Vakuumbbeutel mit Etiketten

1. Modell und Beschreibung 2. Menge 3. Versanddatum 4. Achtung





## Paketlösung für große Bestellungen

Schaumstoffplatten zwischen  
die Tablettts legen



Schaumstoffplatten sind etwas  
größer als Tablettts



Legen Sie Schaumstoffplatten und  
Tablettts in die Schachtel



Schaumstoffplatten sind eng anliegende Box





## Paketlösung für kleine Bestellungen

Legen Sie die Schaumstoffplatten und  
Tablets in die kleine Schachtel



Schaumstoffplatten passen gut in  
die kleine Box



Paket in kleiner Box für den Versand



Legen Sie kleine Kartons in größere Kartons





## Carbon Box Paketlösung

Verschließen Sie die Carbonbox

Beschriftete Schachtel mit Endverpackung



### Versandfertige Karbonbox

1. Lieferadresse und Telefonnummer
2. Box-Nr. und Versanddatum
3. Zerbrechliche Vorsicht



## Lösung für Musterbestellungspakete

Legen Sie die Probe in einen kleinen antistatischen Beutel



Stecken Sie die Anschlüsse in den kleinen antistatischen Beutel



### Musteretiketten auf dem kleinen Beutel

1. Kameramodul oder Anschlussmodell 2. Lieferdatum und Menge 3. Achtung





## Connectors Large Order Package Solution

Steckverbinder in einem Rad



Steckverbinder im Rad beschriftet



Das Rad passt perfekt in die Box



Steckerbox versandfertig



**Unternehmen Kai Lap Technologies (KLT)**

Kai Lap Technologies Group Limited. (KLT) wurde 2009 gegründet und ist ein technologiegetriebener Hersteller der nächsten Generation, der sich auf Forschung, Design und Produktion von Audio- und Videoprodukten spezialisiert hat. KLT verfügt über 20.000 Quadratfuß automatisierte Fabriken mit 100 Mitarbeitern und einem jährlichen Durchsatz von 30.000.000 Kameraeinheiten.

KLT bietet OEM-, ODM-Design, Auftragsfertigung und baut die Kameraprodukte. Sie können uns die Anforderungen auch mit einem Handentwurf übermitteln, unser Vertrieb und unsere Technik arbeiten zusammen, um Ihre Anforderungen zu erfüllen. Wir verstehen uns als Ihr langfristiger Partner bei der Entwicklung praktischer und innovativer Lösungen.

Unser Team deckt alles von der ersten Konzeptentwicklung bis zum Massenprodukt ab. KLT ist spezialisiert auf kundenspezifisches Kameradesign, Rohmaterial, Elektrotechnik, Firmware-/Softwareentwicklung, Produkttests und Verpackungsdesign. Unsere erfahrenen strategischen Versorgungssysteme bieten eine robuste und zuverlässige Fertigungskapazität für Aufträge unterschiedlicher Größe.

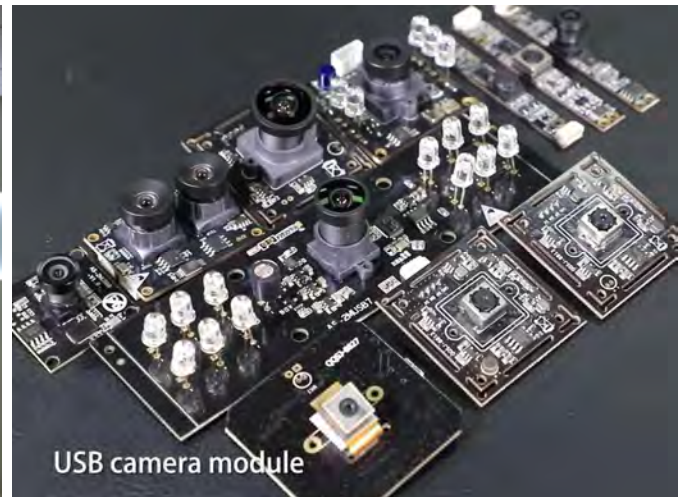
**Eingeschränkte Garantie**

KLT gewährt die folgende eingeschränkte Garantie, wenn Sie das/die Produkt(e) direkt von der Firma KLT oder von der Website von KLT, [www.KaiLapTech.com](http://www.KaiLapTech.com), gekauft haben. Produkte, die von anderen Verkäufern oder Quellen gekauft wurden, fallen nicht unter diese beschränkte Garantie. KLT garantiert, dass das/die Produkt(e) bei normalem Gebrauch für einen Zeitraum von einem (1) Jahr ab dem Datum, an dem Sie das Produkt erhalten („Garanzzeitraum“), frei von Material- und Verarbeitungsfehlern sind.

Für alle Produkte, die während des Garanzzeitraums Material- oder Verarbeitungsfehler enthalten oder entwickeln, wird KLT nach eigenem Ermessen entweder: (i) die Produkte reparieren; (ii) das/die Produkt(e) durch ein neues oder generalüberholtes Produkt(e) ersetzen (Ersatzprodukt(e) sind von identischem Modell oder funktionell gleichwertig); oder (iii) Ihnen den Preis erstatten, den Sie für das/die Produkt(e) gezahlt haben.

Diese eingeschränkte Garantie von KLT ist ausschließlich auf Reparatur und/oder Ersatz zu den oben genannten Bedingungen beschränkt. KLT ist nicht zuverlässig oder verantwortlich für nachfolgende Ereignisse.





*your BEST camera module partner*

## KLT Stärke

Leistungsstarke Fabrik



## Professioneller Service



## Versprochene Lieferung

